

TEXTURE NATALIZIA

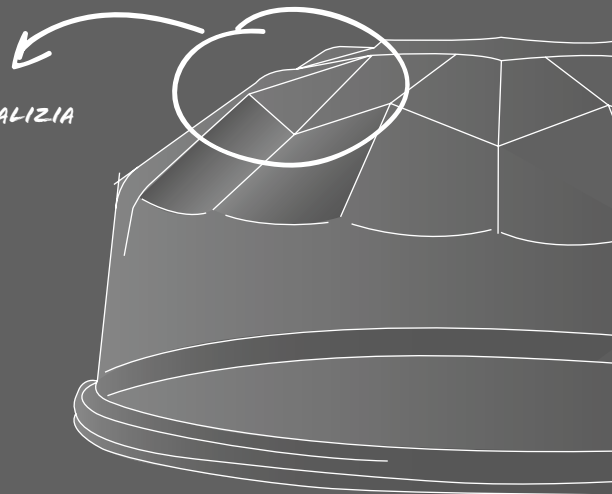

175

75

120

35

INDUSTRIAL FOOD CONTAINER DESIGN

4 PEZZI

SEZIONE B-B'

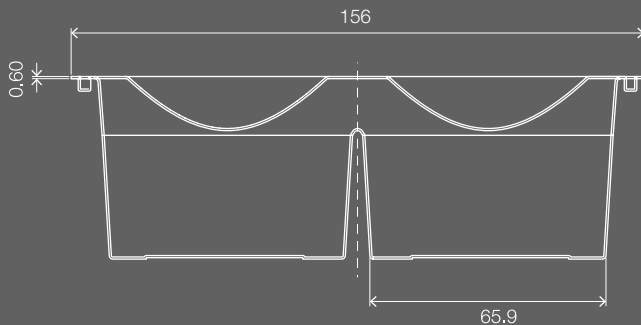

SEZIONE B-B'

CONTENITORE
CUPCAKE

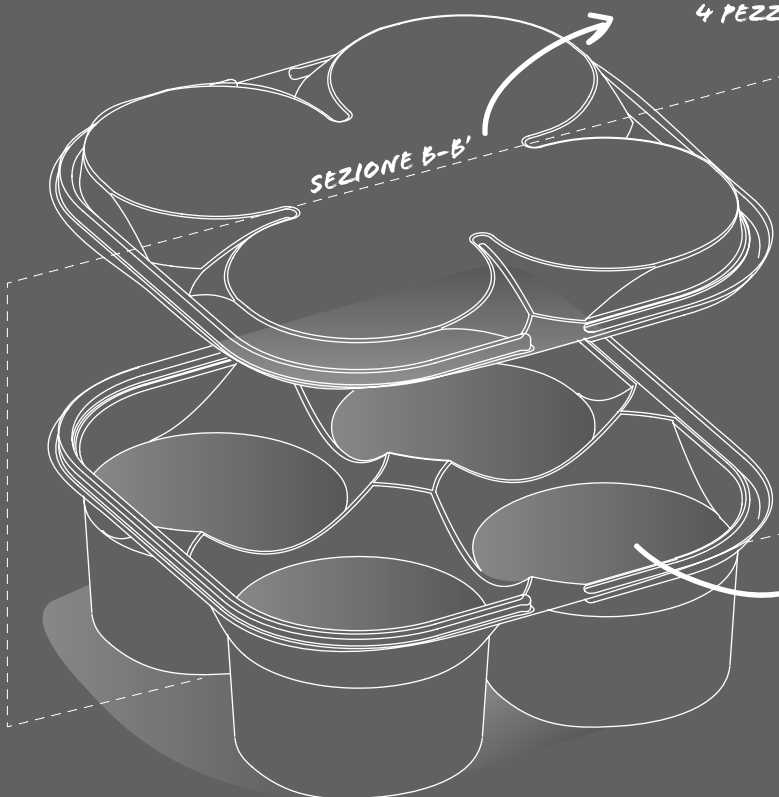

POLOPLAST
food containers

INDEX

4_7
Company Profile

8_11
Design of product

12_25
Containers for pastry

26_45
Containers for Ice Cream

46_51
Spoon selection

52_57
Compostable

OUR COMPANY

A STRONG REALITY

Poloplast è oggi una solida realtà nella produzione di packaging per alimenti, con una gamma che conta oltre 230 linee di articoli, specializzata nel settore della gelateria, della pasticceria e del catering. Nata nel 1994 è in costante evoluzione in un'ottica di innovazione e sostenibilità, con un processo industriale sempre più efficiente e sicuro, riducendone l'impronta ecologica.

Poloplast is a strong reality in the foodstuff packaging industry, with a range counting more than 230 product lines, specialized in ice cream, pastry and catering sectors. Founded in 1994, it is constantly evolving with a view to innovation and sustainability, with an increasingly efficient and safe industrial process, and reducing its ecological impact.



Processo di programmazione per il reparto produttivo



Processo di produzione di termoformatura



Processo di produzione ad iniezione



Poloplast dal 2012 è attenta alle più stringenti direttive europee e si sottopone costantemente a certificazioni in merito a sicurezza alimentare. Poloplast, inoltre, è la prima azienda produttrice di packaging Made in Italy per alimenti ad aver conseguito entrambe le certificazioni BRC PACKAGING - GRADE AA e ISO9001:2015.

Poloplast since 2012 is attentive to the most stringent European directives and is constantly subjected to certifications regarding food safety. Poloplast is also the first manufacturer of Made in Italy packaging for food to have achieved both BRC PACKAGING - GRADE AA and ISO9001: 2015 certifications.

PRODUCTION PROCESS & PACKAGING

Da sempre l'azienda ha investito in nuove tecnologie per aumentare la capacità produttiva, l'efficienza, la qualità dei prodotti e la velocità di produzione. La nostra ampia gamma di prodotti e servizi include metodi di produzione e di personalizzazione dei prodotti, dall'iniezione alla termoformatura, fino alla personalizzazione stampa. Questo significa che, in qualità di tuo partner commerciale, possiamo implementare una combinazione di tecnologie diverse e fornirti sempre una soluzione affidabile, con oltre 25 anni di esperienza nello stampaggio, possiamo trovare soluzioni perfette per il tuo packaging su misura.

Poloplast has always invested in new technologies to increase production capacity, efficiency, product quality and production speed. Our wide range of products and services includes methods of production and personalization of the products, from injection to thermoforming, up to print personalization. This means that, as your commercial partner, we can implement a combination of different technologies and always provide you with a reliable solution, with over 25 years of molding experience; we can find perfect solutions for your customized packaging.

Lo sviluppo, la produzione e personalizzazione di soluzioni di packaging innovative ed efficienti costituisce il fulcro delle competenze di Poloplast. Con oltre 12.000.000 di pezzi prodotti ogni giorno esclusivamente in Italia, Poloplast è uno dei maggiori leader di questo settore. Supporto al cliente, innovazione ed esperienza nel settore fanno di noi il partner da scegliere.

The development, production and customization of innovative and efficient packaging solutions are at the heart of Poloplast's expertise. With over 12,000,000 pieces produced every day exclusively in Italy, Poloplast is one of the leaders in this sector. Customer support, innovation and industry experience make us the best partner to choose.



GREEN SHELF SALES

RIUTILIZZARE REUSE



Massimizziamo l'utilizzo di materie prime provenienti da fonti sostenibili.

We maximize the use of raw materials from sustainable sources.



INNOVARE INNOVATE



Ci impegnamo costantemente per la lotta allo spreco, innovando costantemente prodotti, processi e servizi.

We are constantly committed to fighting waste, innovating products, processes and services.



EDUCARE EDUCATE



Supportiamo e promuoviamo continuamente l'utente sull'importanza del riciclo.

We continuously support and promote the user on the importance of recycling.

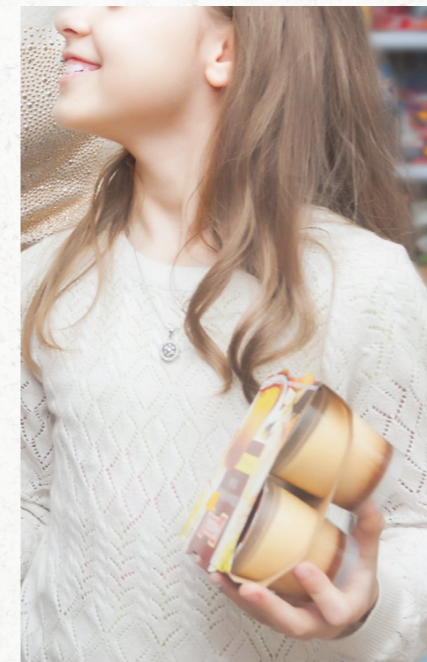

La sostenibilità e la riduzione dell'impatto sull'ambiente sono da sempre le linee guida di Poloplast, non a parole ma con i fatti, utilizzando plastica 100% riciclabile, materiali biodegradabili e compostabili e macchinari ad elevato risparmio energetico. Innovare e preservare l'ambiente, perché il futuro è oggi.

Sustainability and reducing our impact on the environment have always been Poloplast's guidelines, not with words but with facts. We use 100%-recyclable plastic, biodegradable and compostable materials and energy-saving machines. Innovating and preserving the environment, because the future is today.



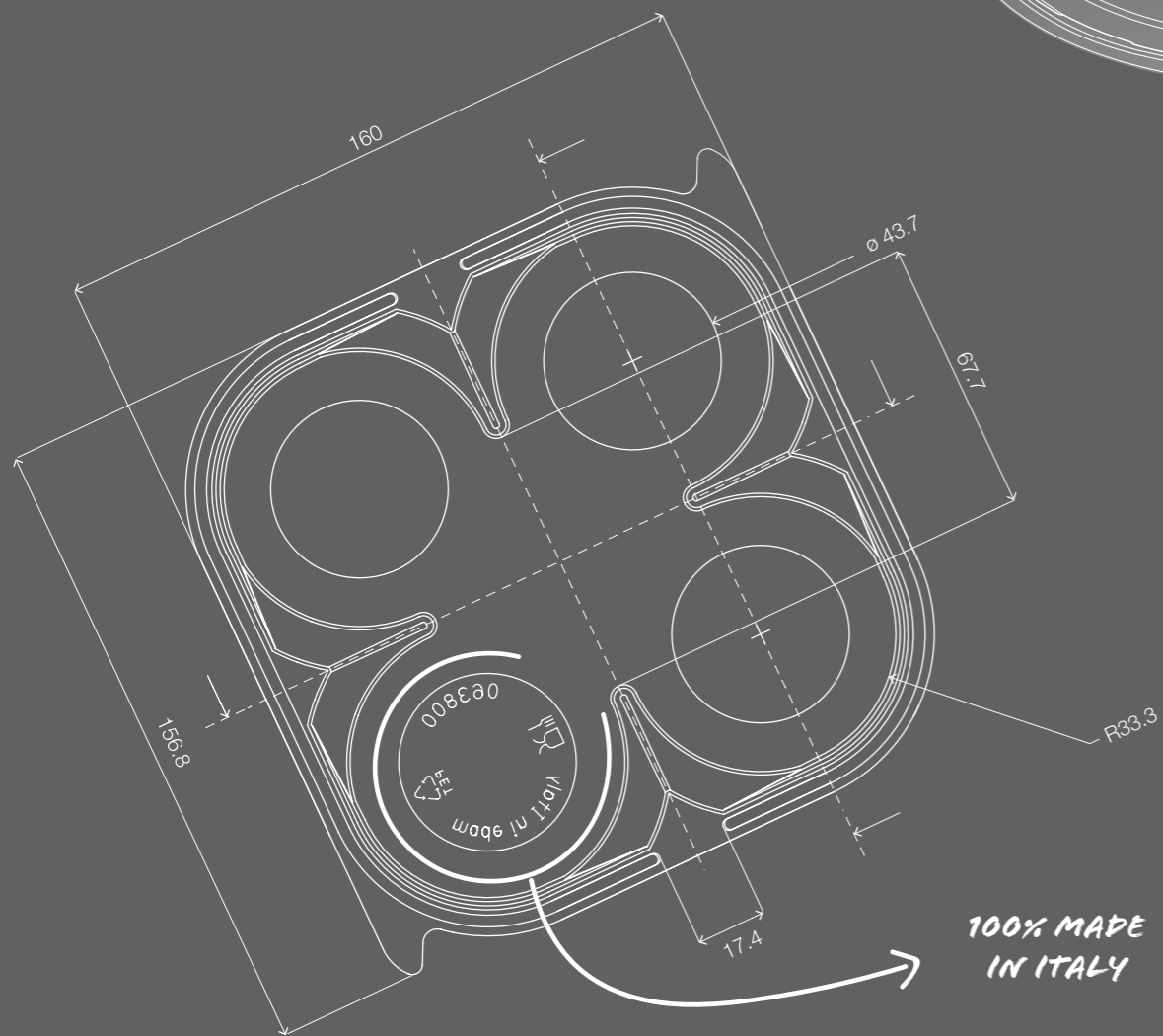
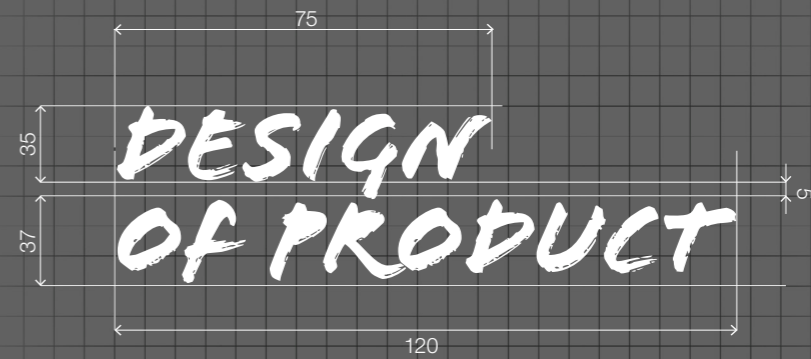
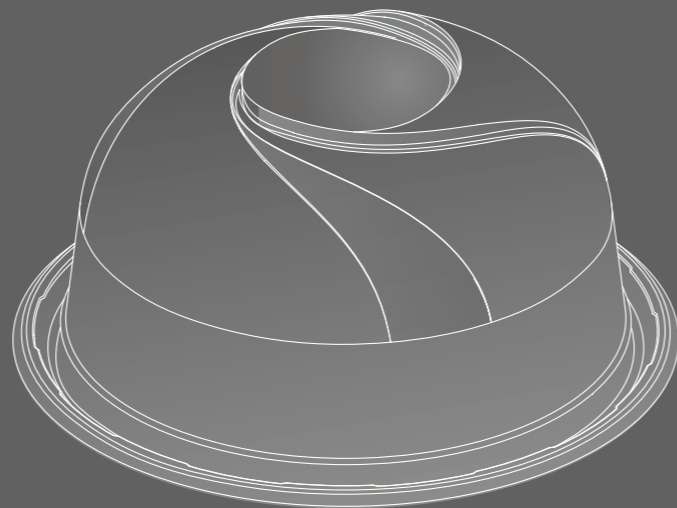
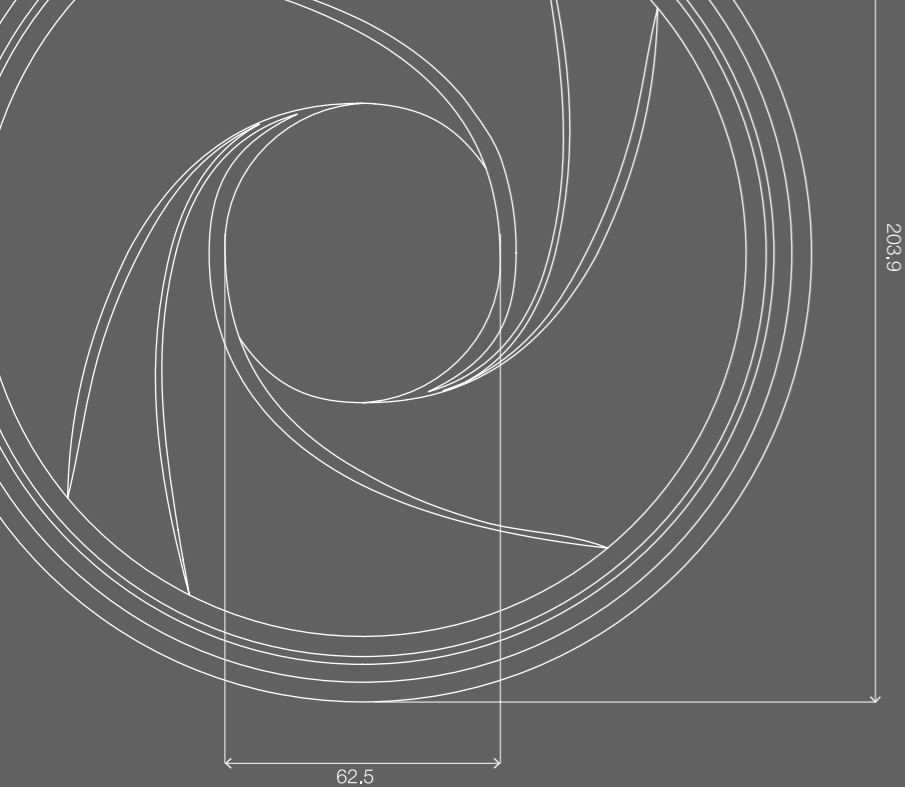

100% MADE
IN ITALY

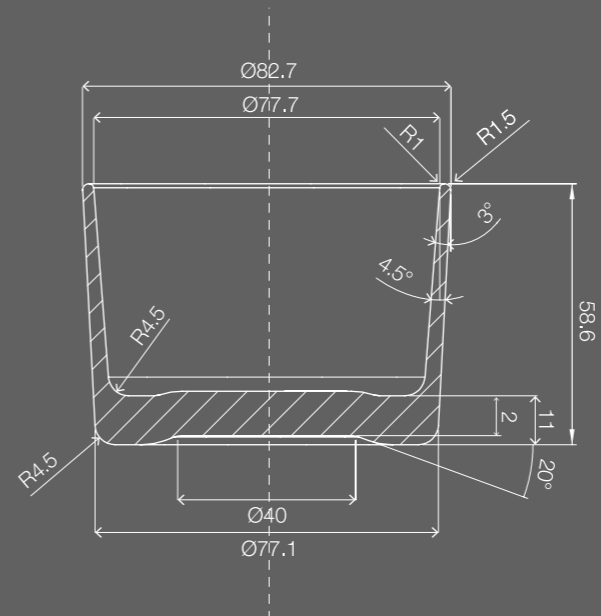

PARTNER IN YOUR CUSTOM

1. BRIEFING

Progettare e produrre nuove soluzioni di packaging vincenti sono procedure molto complesse, perciò nel primo incontro definiamo assieme al cliente le sue necessità, finalità ed eventuali parametri.

To design and develop a new packaging solution is not easy. The first step is to define all customer's needs, parameters and final use.

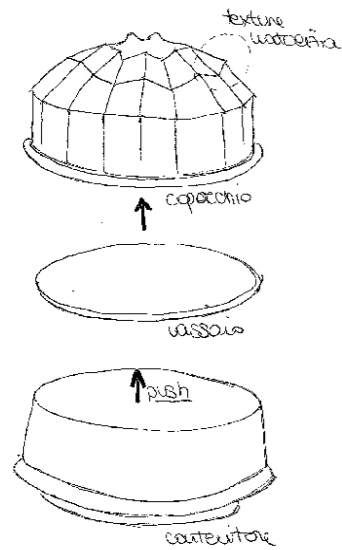

2. ADVICE

Il nostro team si immerge nel processo creativo analizzando i prodotti dei competitor, validando le proposte e presentando un primo concept su misura per il cliente. Dopo aver presentato le nostre idee al cliente, discutiamo un'ampia gamma di aspetti nel dettaglio: protezione del prodotto, vita sullo scaffale, sostenibilità, requisiti legali, processi automatizzati di confezionamento e logistica, costi e molto altro ancora.

OBIETTIVI:

Presentazione del primo concept	Sottoporre le varie possibilità tecniche	Definire la tecnologia
---------------------------------	--	------------------------

Our creative team studies the products of our competitors, takes into consideration the different options and prepares a first custom-made concept.

After showing our ideas to the customer, we discuss about further details: product protection, shelf life, sustainability, legal requirements, robotised packing processes, logistics, costs and much more.

TARGETS:

Presentation of the first concept	Discussion about the different technical possibilities	Definition of the technology
-----------------------------------	--	------------------------------

3. 3D MODEL

Utilizziamo i più aggiornati software CAD per garantire i più elevati standard fin dall'inizio. Su richiesta del cliente possiamo creare dei prototipi tridimensionali per avere un'idea chiara del prodotto finito.

OBIETTIVI:

Rendering 3D	Approvazione design	Analisi costi-benefici	Prototipazione rapida	Presentazione modello 3D
--------------	---------------------	------------------------	-----------------------	--------------------------

With the use of modern Cad software, we can achieve high standard levels from the beginning of the project. If requested from the customer we can realize three-dimensional prototypes of the product to show the final result.

TARGETS:

3D rendering	Design of approval	Cost-benefit analysis	Rapid prototyping	Presentation of a 3D model
--------------	--------------------	-----------------------	-------------------	----------------------------

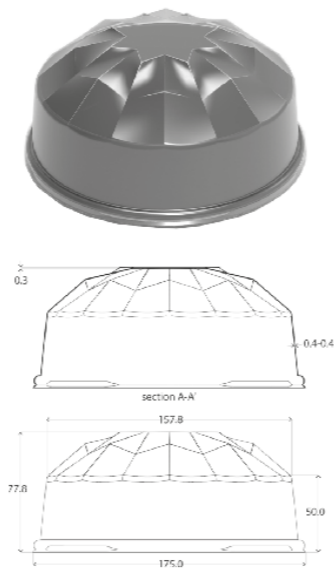

4. CREATION

Iniziamo il complesso procedimento di creazione dello stampo e accessori per la produzione industriale in serie secondo i più elevati standard.

Mettiamo all'opera la nostra ventennale esperienza nella produzione in serie di packaging per alimenti, monitorando costantemente che il prodotto finito mantenga gli standard di qualità approvati dal cliente.

We start with the complex realization of the mould and further components for the industrial large-scale production, according to the highest quality standards. Our twenty-year experience in large-scale manufacturing of food packaging and the regular quality control, guarantees that the final product always maintains the high quality standards approved by the customer.



Assieme ai nostri clienti, creiamo soluzioni di packaging che, sullo scaffale, sono in grado di fare leva sulle emozioni dei consumatori. Un'esperienza di acquisto studiata ad hoc per i tuoi punti vendita.

Together with our customers, we create packaging solutions that, on the shelf, are able to inspire the emotions of consumers. A shopping experience designed specifically for your stores.

5. CUSTOM

Siamo il partner di fiducia delle principali marche della grande distribuzione organizzata italiana ed internazionale, una relazione leale che risponde prontamente alle vostre richieste con lo sviluppo e l'introduzione di nuovi prodotti sempre più vicini al consumatore. Versatili ma senza perdere di vista il nostro obiettivo imprescindibile: la soddisfazione delle esigenze dei clienti. La nostra esperienza ci permette di offrire, oltre alla nostra grande flessibilità produttiva interna, anche una vasta gamma di prodotti: più di 2.500 forme, che garantiscono ad ogni nostro cliente il prodotto ideale alle sue esigenze. Come esperti consulenti il nostro successo e quello dei nostri clienti passa proprio attraverso il gradimento espresso dai consumatori ai prodotti che sviluppiamo insieme.

We are the trusted partner of the major brands of the Italian and international large-scale retail trade, a loyal relationship that promptly responds to your requests with the development and introduction of new products that are ever closer to the consumer. Versatile but without losing sight of our essential goal: the satisfaction of customer needs. Our experience allows us to offer a great production flexibility and a wide range of products: more than 2,500 shapes, which guarantee to each of our customers the ideal product for their needs. As expert consultants, our success and that of our customers passes through the satisfaction expressed by consumers to the products we develop together.



VASCHETTE MONOPORZIONE CON COPERCHIO

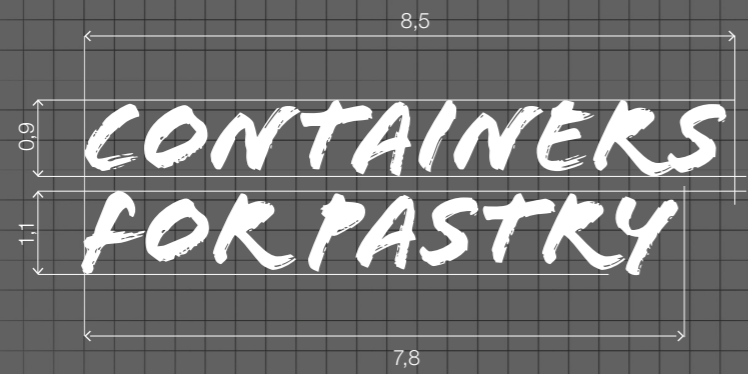

COPERCHIO/LID x40cc
091892 ●
 ø6,5x0,5h - PET/THF
 1000pcs(10x100pcs)

SALSA 40cc
091800 ○
 ø5,1x3,2h - PS/THF
 1000pcs(10x100pcs)



SALSA 30cc
 CON COPERCHIO/WITH LID
610 ●
 ø5,5x2,5h - PET/THF
 600pcs(6x100pcs)



COPERCHIO/LID
POLO80COP ●
 11x11 - PET/THF
 2000pcs(20x100pcs)

200cc
POLO80 ●
 10,4x10,4x4,4h - PET/THF
 2000pcs(40x50pcs)



COPERCHIO/LID x150cc
062692 ●
 7,2x7,2x1,5h - PET/THF
 1000pcs(20x50pcs)

ICE CUBE 150cc
062600 ●
 7x7x4,7h - PET/THF
 1000pcs(20x50pcs)



COPERCHIO/LID
POLO110COPNEW ●
 14,9x10x3,2h - PET/THF
 350pcs(7x50pcs)

400cc
POLO110NEW ●
 16,4x11,6x4,2h - PET/THF
 350pcs(7x50pcs)



COPERCHIO/LID
062592 ●
 15,7x10x4,3h - PET/THF
 500pcs(10x50pcs)

TIRAMISÙ
062501 ●
062502 ●
062500 ●
 15,5x10x2,3h - PET/THF
 500pcs(10x50pcs)



VASSOI PORZIONE DESSERTS



MINI
063700 ●
6,5x11x2,5h - PET/THF
1250pcs(25x50pcs)



RETTANGOLARE
063400 ●
21x11x3h - PET/THF
300pcs



QUATTRO SCOMPARTI
063600 ●
21,6x12,6x2,53h - PET/THF
300pcs(4x75pcs)

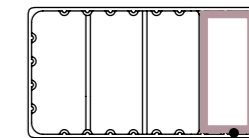

4,2x9,3cm

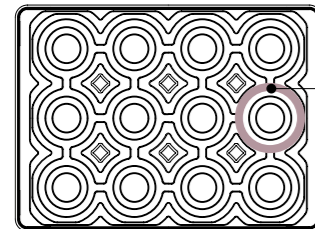

Ø8cm

12 POSE/12 PIECES
062400 ●
39,5x27,5 - PET/THF
110pcs

COPERCHIO/LID
062492 ●
h6cm (38,2x28cm) - PET/THF
110pcs



OTTO SCOMPARTI
063900 ●
32,7x11,5hx3h - PET/THF
280pcs

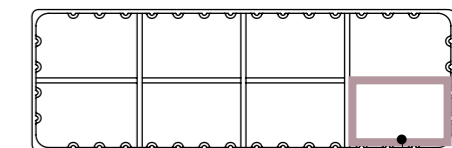

7,2x4,3cm

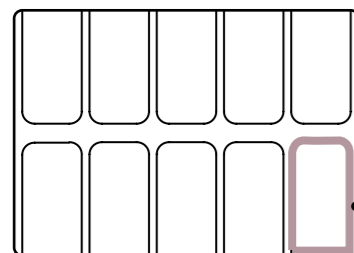

6x13cm

10 POSE/10 SLICES
091700 ●
30x41,5x2h - PET/THF
170pcs



QUADRATO
063500 ●
21x21x3h - PET/THF
200pcs



VASSOI PORTA DESSERTS



COPERCHIO/LID MEDIUM
1212-H65 ●
12x12x6,5h - PET/THF
912pcs(4x228pcs)



COPERCHIO/LID SMALL
1212-H45 ●
12x12x4,5h - PET/THF
912pcs(4x228pcs)



BASE PICASSO
1212 ●
12x12x0,5h - PET/THF
912pcs(4x228pcs)



COPERCHIO/LID x072200
072292 ●
ø18,8x8,72h - PET/THF
240pcs (1x240pcs)



GIRY
072200 ●
ø18,8 - PET/THF
240pcs (1x240pcs)



COPERCHIO/LID x072000
072100 ●
ø20x6,8h - PET/THF
450pcs(1x450pcs)



INFINITY
072000 ●
ø20x1h - PET/THF
300pcs(1x300pcs)

VASSOI PORTA DELIZIE



COPERCHIO/LID
063892 ●
16x16x1,5h - PET/THF
400pcs



MUFFIN
063800 ●
16x16x5,04h - PET/THF
200pcs

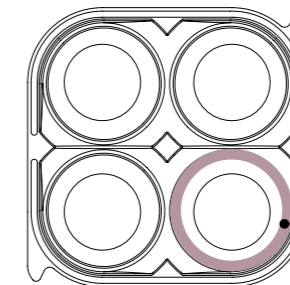

Ø6,5cm

4 POSE/4 PIECES



SPICCHIO
062900 ●
12x8x4,2h - PS/INJ
200pcs(20x10pcs)

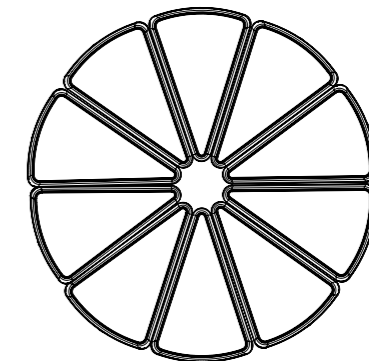

10 SPICCHI FORMANO UNA TORTA
FOR A CAKE WITH 10 SLICES

VASSOI PORTA DOLCETTI



MACARON 4 POSE
063000 ●
063001 ●
 11,9x13,6x3,3h - PET/THF
 100pcs(4x25pcs)

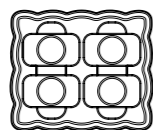

MACARON 8 POSE
063100 ●
063101 ●
 18,8x13,7x5h - PET/THF
 100pcs(4x25pcs)

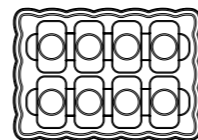

MACARON 12 POSE
063200 ●
063201 ●
 26,2x13,8x5h - PET/THF
 100pcs(4x25pcs)

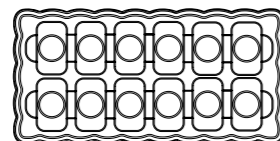

PETIT 9 POSE
061100 ●
 17,8x17,8x5,1h - PET/THF
 100pcs(2x50pcs)

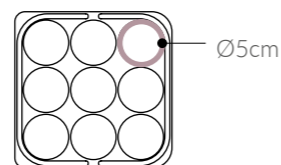

VASSOI TORTA CON COPERCHIO



COPERCHIO/LID
040692 ●
 ø17,5x7,95h - PET/THF
 240pcs(8x30pcs)



CRISTALLO
040600 ●
 ø17,3x6h - PET/THF
 120pcs(4x30pcs)



ISTRUZIONI D'USO / INSTRUCTIONS FOR USE

Rimuovi il coperchio (1) e facendo leva sulla fascia (3) spingi il fondo (2) verso l'alto.
 Ecco servito il tuo dolce.
 Remove the lid (1) grab the band (3) lift up the bottom (2).
 Here you are your cake.



EASY OPEN
070800 ●
 Ø19x8,5h - PET/THF
 25pcs(1x25pcs)



ISTRUZIONI D'USO / INSTRUCTIONS FOR USE

Crea la tua torta e riponila nel congelatore/ Create your cake and put it in the freezer.
 Togli il coperchio (1) e, aiutandoti con le due linguette inferiori, spingi e solleva il fondo (3)/ Remove the lid (1) and with the help of bottom flaps, push and lift the bottom tray (3).
 Utilizza il pratico vassoio (2) per esporre la tua torta/ Use the tray (2) to serve and show your cake.

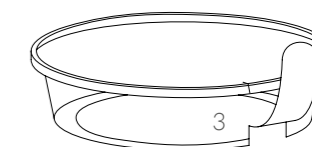

Linguette/Flaps

CONTENITORI RIGIDI



TIRAMISÙ 1150cc
170 ●
22,3x12,3x4,5h - PS/INJ
50pcs(2x25pcs)

TIRAMISÙ 1560cc
171 ●
26,6x15,6x4,5h - PS/INJ
50pcs(2x25pcs)

TIRAMISÙ 2160cc
172 ●
30,2x18,6x4,5h - PS/INJ
50pcs(2x25pcs)



TIRAMISÙ 1150cc
170-18 ●
22,3x12,3x4,5h - PS/INJ
50pcs(2x25pcs)

TIRAMISÙ 1560cc
171-18 ●
26,6x15,6x4,5h - PS/INJ
50pcs(2x25pcs)

TIRAMISÙ 2160cc
172-18 ●
30,2x18,6x4,5h - PS/INJ
50pcs(2x25pcs)

VASSOI RIGIDI



OVALE
094 ●
25,5x12,5x2,5h - PS/INJ
10kg(204pcs ca.)

OVALE
095 ●
29x14,5x3h - PS/INJ
10kg(160pcs ca.)

OVALE
096 ●
33x16,5x3,5h - PS/INJ
10kg(120pcs ca.)



OVALE
097 ●
38x19,5x4h - PS/INJ
10kg(78pcs ca.)

OVALE
098 ●
46x22,5x5h - PS/INJ
10kg(50pcs ca.)

OVALE
099 ●
53x27x5h - PS/INJ
10kg(32pcs ca.)



ZUCCOTTO 750gr
004 ●
ø15,5x8,5h - PS/INJ
50pcs(2x25pcs)



ZUCCOTTO 500gr
003 ●
ø13,5x7,1h - PS/INJ
50pcs(2x25pcs)



ELIKONE
120 ●
36x23,5x5,5h - PS/INJ
50pcs(2x25pcs)



PROFITTEROL
119-19 ●
36x23x4,5h - PS/INJ
52pcs(2x26pcs)

VASSOI GOLDEN AGE



070000N ●
 ø6 - PET/THF
 1000pcs(10x100pcs)

COPERCHIO/LID x ø9,5
070092 ●
 ø9,5x5h - PET/THF
 600pcs(12x50pcs)

070100N ●
 ø9,5 - PET/THF
 1000pcs(10x100pcs)

COPERCHIO/LID x ø12
706-BB ●
 ø13,1x5,7h - PET/THF
 800pcs(8x100pcs)

COPERCHIO/LID x ø12
070192 ●
 ø12x6h - PET/THF
 250pcs(5x50pcs)

070200N ●
 ø12 - PET/THF
 1000pcs(10x100pcs)

COPERCHIO/LID x ø15
070292 ●
 ø16,2x9h - PET/THF
 250pcs(5x50pcs)

070300N ●
 ø15 - PET/THF
 500pcs(5x100pcs)

COPERCHIO/LID x ø18
070392 ●
 ø18x8h - PET/THF
 150pcs(3x50pcs)

070400N ●
 ø18 - PET/THF
 300pcs(3x100pcs)



COPERCHIO/LID x ø15
121/22H9 ●
 ø22x9h - PET/THF
 125pcs(1x125pcs)

COPERCHIO/LID x ø22
121/22C ●
 ø22x8h - PET/THF
 125pcs(1x125pcs)

121/22N ●
 ø22 - PET/THF
 125pcs(1x125pcs)



COPERCHIO/LID x ø24
121/24H9 ●
 ø24x9,5h - PET/THF
 125pcs(1x125pcs)

COPERCHIO/LID x ø24
121/24C ●
 ø24x7,5h - PET/THF
 125pcs(1x125pcs)

121/24N ●
 ø24 - PET/THF
 125pcs(1x125pcs)



COPERCHIO/LID x ø26
121/26H9 ●
 ø26x9h - PET/THF
 125pcs(1x125pcs)

COPERCHIO/LID x ø26
121/26C ●
 ø26x8h - PET/THF
 125pcs(1x125pcs)

121/26N ●
 ø26 - PET/THF
 125pcs(1x125pcs)



COPERCHIO/LID
OLYMPOCOP ●
 16x23x7,5h - PET/THF
 200pcs(8x25pcs)

070500N ●
 15x22 - PET/THF
 150pcs(6x25pcs)



COPERCHIO/LID
070692 ●
 15x30x9,5h - PET/THF
 75pcs(3x25pcs)

070600N ●
 15x30 - PET/THF
 150pcs(6x25pcs)



COPERCHIO/LID
070792 ●
 15x35x9,5h - PET/THF
 75pcs(3x25pcs)

070700N ●
 15x35 - PET/THF
 150pcs(6x25pcs)

Disponibili in diverse misure/Available in different sizes



VASSOI RIGIDI DA BANCO FRIGO

Pratici e resistenti vassoi per ogni tipo di torta.
Practical and strong trays, for every type of cake.



PAPERINO 30x40
114/1 ◯
30x40x1,5h - PS/INJ
10kg(34pcs ca.)

114/1-08 ●
114/1-11 ●
114/1-14 ●
114/1-23 ●
114/1-24 ●
30x40x1,5h - PS/INJ
30pcs(2x15pcs)



PAPERINO 36x48
114/2 ◯
36x48x1,5h - PS/INJ
10kg(26pcs ca.)

114/2-04 ●
114/2-08 ●
114/2-11 ●
114/2-14 ●
114/2-23 ●
114/2-24 ●
36x48x1,5h - PS/INJ
20pcs(2x10pcs)

MONOPORZIONI CON COPERCHIO



Bicchierini dalla forma lineare, ideali per produzioni industriali in quanto macchinabili.
Small glasses with linear shape, ideal for industrial productions.



COPERCHIO/LID x TUBITO
415-CB ●
ø5,5 - PET/THF
600pcs(12x50pcs)



COPERCHIO/LID x TUBITO
415-CB ●
ø5,5 - PET/THF
600pcs(12x50pcs)



TUBITO 120cc
416 ●
416-11 ●
ø5,3x7h - PS/INJ
300pcs(6x50pcs)



TUBITO 150cc
415 ●
ø5,5x9h - PS/INJ
200pcs(4x50pcs)

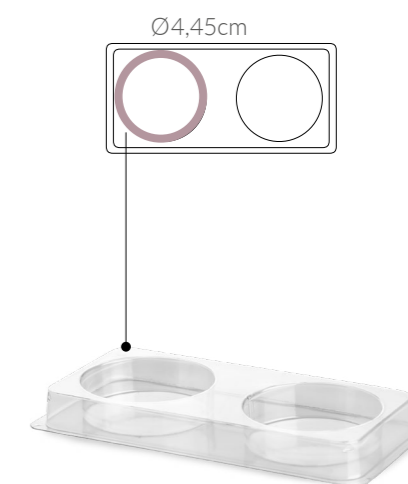

PORTA TUBITO
416000 ●
12,3x6xh1,4 - PET/THF
300pcs(6x50pcs)

425CIN

Innovazione e tendenza con un semplice gesto! Facile da incastrare per la tua produzione, facile da togliere per il tuo cliente. Il coperchio Cin è adatto per cucchiaino Remo e la monoporzione Victoria 210cc.

Innovation and tendency in one click! Easy to assemble for your production and easy to remove for your clients. CIN lid is suitable for Remo spoon and for Victoria 210cc.

Il coperchio 425CIN è stato premiato come una delle soluzioni di packaging più innovative ed ecosostenibili immesse sul mercato in occasione del Bando Conai per la Prevenzione 2018. Il coperchio è frutto del continuo impegno di Polo Plast per l'innovazione e la sostenibilità ambientale delle proprie soluzioni di packaging.

I principali benefici di questa soluzione:

- risparmio di materia prima
- semplificazione del sistema imballo
- ottimizzazione dei processi produttivi
- ottimizzazione della logistica

Item 425CIN lid was awarded as one of the most innovative and environmentally sustainable packaging solutions launched on the market by "Bando Conai per la Prevenzione 2018". The lid is the result of the continuous commitment of Polo Plast for the innovation and environmental sustainability of its packaging solutions.

The main benefits of this solution are:

- raw material saving
- simplification of the packaging system
- optimization of production processes
- optimization of logistics

Gourmet, unico coperchio per tre monoporzioni: ideale per l'industria o per un tris di assaggi. Potrete completare il vostro packaging con un'etichetta che faccia da sigillo di garanzia.

Gourmet, one lid for three cups: ideal for industry or for three tastes. You can complete your packaging with a label as seal closure.



COPERCHIO/LID x58cc
420-BB ●
5x5x1h - PET/THF
650pcs(13x50pcs)

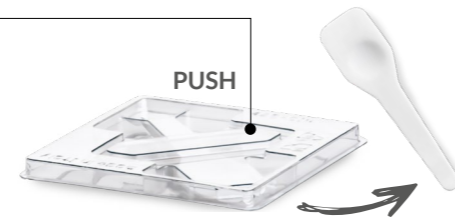

COPERCHIO/LID x210cc
425CIN ●
L.8x8x1h - PET/THF
1200pcs(1x1200pcs)



COPERCHIO/LID x58cc
420-CB ●
5x5 - PET/THF
650pcs(13x50pcs)



COPERCHIO/LID x120cc
426-CB ●
6,2x6,2 - PET/THF
500pcs(10x50pcs)



COPERCHIO/LID x210cc
425-CB ●
7,1x7,1 - PET/THF
500pcs(10x50pcs)



CUPIDO 58cc
420 ●
420-11 ●
5x5x4,5h - PS/INJ
650pcs(13x50pcs)



ERA 120cc
426 ●
426-11 ●
6,2x6,2x5,8h - PS/INJ
500pcs(10x50pcs)



VICTORIA 210cc
425 ●
7,1x7,1x7,2h - PS/INJ
500pcs(10x50pcs)



COPERCHIO/LID x60cc
445-BB ●
4x4x1,1h - PET/THF
500pcs(10x50pcs)



COPERCHIO/LID x120cc
446-BB ●
5x5x1,1h - PET/THF
500pcs(10x50pcs)



COPERCHIO/LID x160cc
448-BB ●
5,5x5,5x1,1h - PET/THF
500pcs(10x50pcs)



KUBIK SMALL 60cc
452 ●
4x4x5,2h - PS/INJ
500pcs(10x50pcs)



KUBIK MEDIUM 120cc
453 ●
5x5x7,3h - PS/INJ
500pcs(10x50pcs)



KUBIK LARGE 160cc
448 ●
5,5x5,5x8h - PS/INJ
500pcs(10x50pcs)

MONOPORZIONI RIGIDE



DESIDERIA 240cc
900 ●
ø7,7x11,2h - PS/INJ
210pcs(35x6pcs)



COPERCHIO/LID X DESIDERIA
900-CB ●
ø7,7 - PET/THF
840pcs(4x210pcs)



MIA 200cc
066000 ●
ø8,6x4,4h - PS/INJ
400pcs(20x20pcs)



COPERCHIO/LID X MIA
609-COP-NEW ●
ø8,6x4h - PET/THF
50pcs



PRIMAVERA 220cc
160 ●
ø10x5h - PP/INJ
250pcs(10x25pcs)



PRIMULA 200cc
166 ●
ø10x6,3h - PS/INJ
250pcs(5x50pcs)



DANIELA 115cc
089 ●
ø7,2x6,4h - PS/INJ
200pcs(2x100pcs)



MARIANNA 200cc
410C ●
ø7,5x12,4h - PS/INJ
500pcs(5x100pcs)



CHARLOTTE 180cc STRONG
469 ●
ø8x5,9h - PS/INJ
50pcs(10x5pcs)



CHARLOTTE 180cc LIGHT
468-IND ●
ø8x5,9h - PS/INJ
112 pcs



COPERCHIO/LID X CHARLOTTE
469-CB ●
ø8,7x2,1h - PET/THF
600pcs(12x50pcs)



COPERCHIO/LID X CHARLOTTE
469-BB ●
ø9x4h - PET/THF
600pcs(12x50pcs)



TARTUFO 90cc
609 ●
609-19 ●
Cup. ø8,6x5,6h / Cop.h4
PP+PET/INJ+THF
500pcs(10x50pcs)



TARTUFO 120cc
608 ●
608-19 ●
Cup. ø8,6x6,6h / Cop.h4
PP+PET/INJ+THF
500pcs(10x50pcs)



BASE TARTUFO 120cc
608-19SC ●
Cup. ø8,6x6,6h - PP/INJ
500pcs(10x50pcs)



COPERCHIO/LID x120cc
702-BB ●
ø9,2x4,3h - PET/THF
1200pcs(12x100pcs)



DELIZIA 180cc
413 ●
ø7,5x7h - PS/INJ
375pcs(15x25pcs)



COPERCHIO/LID X DELIZIA
252-BB ●
ø7,5x2,3h - PET/THF
1000pcs(10x100pcs)



COPERCHIO/LID X DELIZIA
252-CB ●
ø7,5x0,8h - PET/THF
1000pcs(10x100pcs)



FLY 200cc
449 ●
ø7,8x5,7h - PS/INJ
600pcs(24x25pcs)



FLY 180cc
459 ●
ø7,8x5,2h - PS/INJ
600pcs(24x25pcs)



COPERCHIO/LID x FLY
449-CB ●
ø8,5x0,7h - PET/THF
600pcs(12x50pcs)



VASCHE DA
GELATO

1,0
1,6
0,2
4,8

VASCHE BIGUSTO

Vasche da gelato adatte a banchi di profondità 36 cm
Ice cream containers for 36cm refrigerated counters.

Tassello personalizzabile
Customizable plug

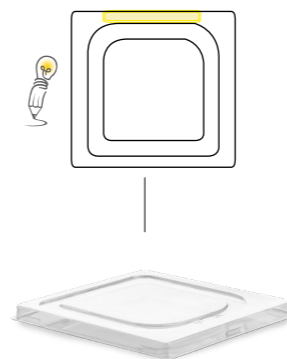

COPERCHIO/LID x L.2,3
Art. 2300-CP ●
18,2x17,2 - PET/THF
336pcs(2x168pcs)

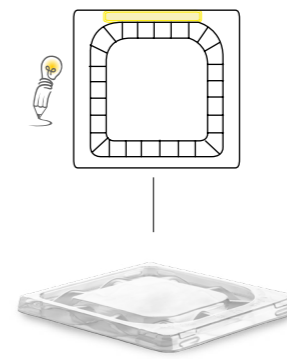

COPERCHIO/LID x L.2,3
Art. 2300-CB ●
18x16,5 - PET/THF
336pcs(2x168pcs)

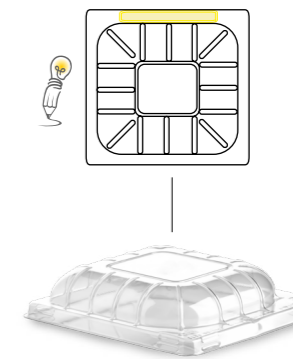

COPERCHIO/LID x L.2,3
2300-BB ●
18,8x17,5x3h - PET/THF
336pcs(2x168pcs)



L.2,3 GRAY
2300-15
18x16,5x12h - PS/THF
168pcs



L.2,3 SILVER
2300-16
18x16,5x12h - PS/THF
168pcs

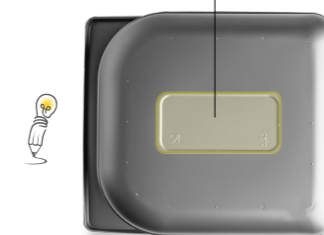

VASCHE 33cm

Vasche da gelato adatte a banchi di profondità 33 cm
Ice cream containers for 33cm refrigerated counters.

Tassello personalizzabile
Customizable plug

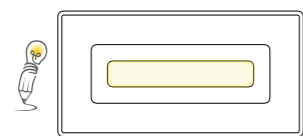

COPERCHIO/LID x L.2,4/3,2/4,2
525-CB ●
33x16,5 - PET/THF
90pcs

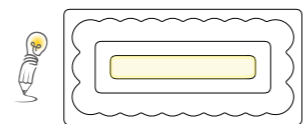

COPERCHIO/LID x L.2,4/3,2/4,2
525-BB ●
33x16,5x6,5h - PET/THF
90pcs



L.2,4 MEDIUM GRAY
527-15
33x16,5x6h - PS-THF
90pcs(3x30pcs)



L.3,2 MEDIUM TRANSPARENT
526-00
33x16,5x8h - PS-THF
160pcs(4x40pcs)



L.4,2 MEDIUM GRAY
525-15
33x16,5x11h - PS/THF
90pcs



VASCHE 33cm

Vasche da gelato adatte a banchi di profondità 33 cm
Ice cream containers for 33cm refrigerated counters.

Tassello personalizzabile
Customizable plug

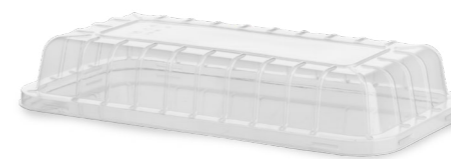
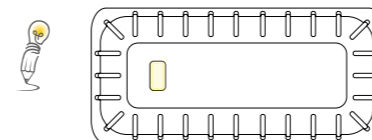

COPERCHIO/LID x L.3,2
528-BB ●
32x17x4,8h - PET/THF
320pcs

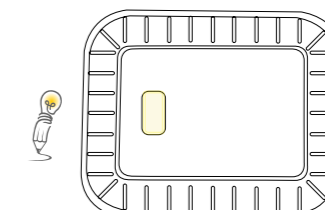

COPERCHIO/LID x L.4,2
522-BB ●
32x25,7x5,2h - PET/THF
180pcs



L.3,2
528-00 ●
31,3x16,4x8h - PET/THF
160pcs



L.4,2
522-00 ●
31,2x24x8h - PET/THF
180pcs



L.4,8
***4750NEWIND ●**
33,5x15,5x12,5h - PET/THF
135pcs(3x45pcs)

*Solo su richiesta. Only upon request.

VASCHE 36cm

Vasche da gelato adatte a banchi di profondità 36 cm
Ice cream containers for 36cm refrigerated counters.

Tassello personalizzabile
Customizable plug

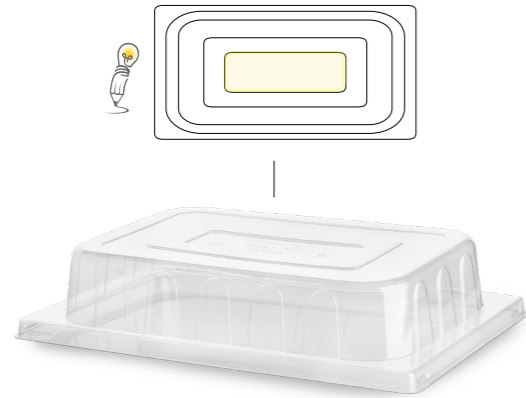

COPERCHIO/LID x L.5,5/8,5
55/85-BB ●
36x25x6h - PET/THF
100pcs



L.5,5 MEDIUM GRAY
5500-16
36x25x8h - PS/THF
100pcs



L.8,5 MEDIUM GRAY
8500-15
36x25x12h - PS/THF
70pcs



VASCHE 36cm

Vasche da gelato adatte a banchi di profondità 36 cm /
Ice cream containers for 36cm refrigerated counters.

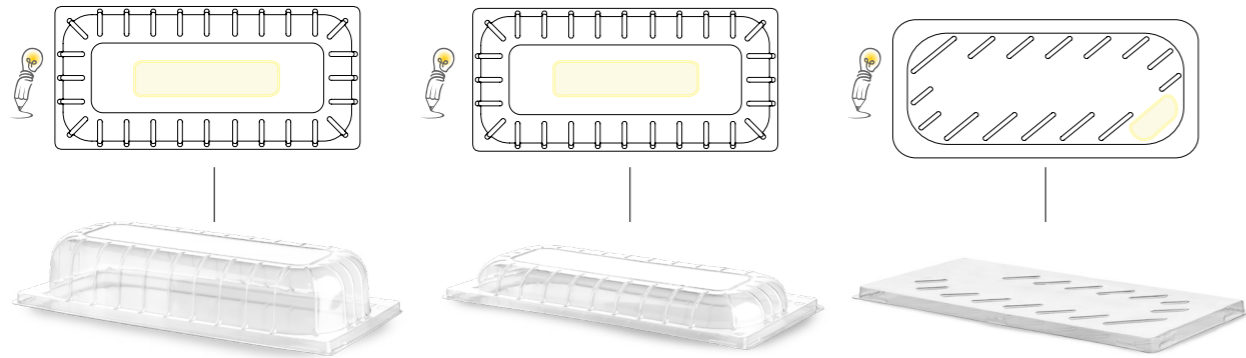

Tassello personalizzabile
Customizable plug

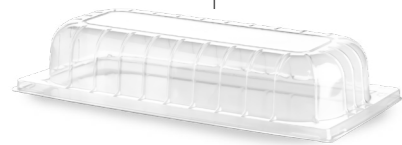

COPERCHIO/LID x L.4,2/4,8
481 ●
36x16,5x6h - PET/THF
135pcs

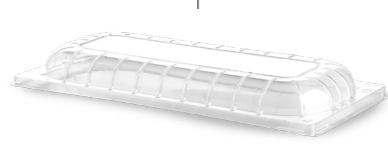

COPERCHIO/LID x L.4,2/4,8
480 ●
36x16,5x3h - PET/THF
135pcs



COPERCHIO/LID x L.4,2/4,8
4750-CP ●
37,3x17,6x1h - PET/THF
270pcs(3x90pcs)



L.4,2 LIGHT GRAY
4750-15
36x16,5x12h - PS/THF
135pcs(3x45pcs)



L.4,8 MEDIUM TRANSPARENT
4750NEW-00 ●
36x16,5x12,5h - PET/THF
90pcs(3x30pcs)



L.4,8 MEDIUM SILVER
4750NEW-16
36x16,5x12,5h - PS/THF
90pcs(3x30pcs)



L.4,8 MEDIUM GRAY
4750NEW-15
36x16,5x12,5h - PS/THF
90pcs(3x30pcs)



L.4,8 STRONG GRAY
475000
36x16,5x12,5h - PS/THF
75pcs (3x25pcs)



VASCHE 36cm CON BORDO PIATTO

Vasche da gelato adatte a banchi di profondità 36 cm
Ice cream containers for 36cm refrigerated counters.

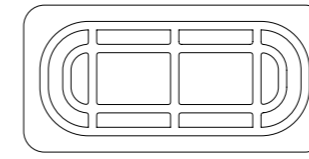

Macchinabile

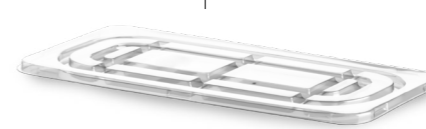

COPERCHIO/LID x L.4,35
Macchinabile
475192 ●
35,6x17,3x0,8h - PET/THF
360pcs

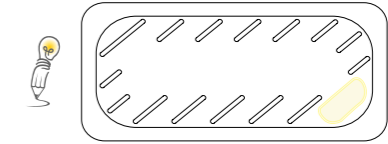

Tassello personalizzabile
Customizable plug

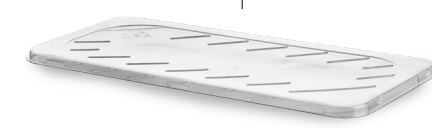

COPERCHIO/LID x L.4,35
475193 ●
35,6x17,3x0,8h - PET/THF
360pcs



L.4,35 MEDIUM SILVER
475101
34,6x16,5x11,2h - PS/THF
120pcs



L.4,35 MEDIUM GRAY
475102
34,6x16,5x11,2h - PS/THF
120pcs



L.2,5 MEDIUM GRAY
475300
34,6x16,5x7h - PS/THF
120pcs



L.4,8 MEDIUM GRAY
475200
34,6x16,5x12,2h - PS/THF
120pcs



CARAPINA



L.6 GRAY
475400
19,9x24,5h - PS/THF
66pcs

L.6 GRAY
474592
19,9x1,5h - PS/THF
132pcs

Carapina è la sorbettiera cilindrica dalla capienza di 6 litri che permette di isolare il gelato da aria, luce e temperatura, conservandolo in uno stato ottimale. Perfetta per i gelati artigianali industriali e non...

Carapina box is the new ice-cream container of 6 liters with cylindrical shape. It allows to separate the ice cream from air, light and temperature and to maintain it in good state. Suitable for industrial and homemade ice cream and not only...

VASCHE CON CHIUSURA A SIGILLO



Tassello personalizzabile
Customizable plug



TAMPER EVIDENT SEAL



COPERCHIO/LID
198C ●
33,5x14,8x0,9h - PP/INJ
200pcs



L.4,5
198 ●
33,76x12x16h - PP/INJ
100pcs

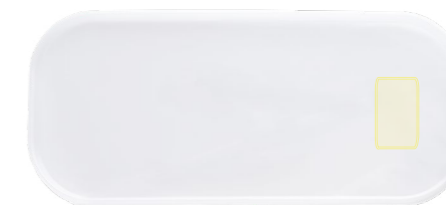

ACCESSORI
& OMAGGI

7,1
0,6
0,3
6,4

SPATOLE PER DOLCI E GELATO

Spatole disponibili in diverse misure, ottime alleate per la pulizia e la preparazione delle vasche gelato. Tutti i modelli sono personalizzabili.

Spatula available in different sizes, excellent allies for the cleaning and preparation of ice cream containers. All models can be customized.

Tassello personalizzabile
Customizable plug



510 ○
5,3x38,5 - PP/INJ
50pcs(1x50pcs)

511 ○
5,5x.34 - PP/INJ
50pcs(1x50pcs)

509 ○
5,3x33,5 - PP/INJ
50pcs(1x50pcs)

517 ●
6,2x31 - ABS+GOMMA
INJ / 50pcs(1x50pcs)

508 ○
5,3x30 - PP/INJ
50pcs(1x50pcs)

514 ○
6,5x25,5 - ABS/INJ
50pcs(1x50pcs)



Area personalizzabile
Customizable area
L4,5x0,7h cm

Area personalizzabile
Customizable area
L3,5x1h cm

Area personalizzabile
Customizable area
L4,5x0,7h cm

Area personalizzabile
Customizable area
L3,5x1h cm

Area personalizzabile
Customizable area
L4,5x0,7h cm

Area personalizzabile
Customizable area
L3x1,5h cm

ARTICOLI PERSONALIZZABILI

Tassello personalizzabile
Customizable plug



SIGILLA SACCHETTO
1001 ○
4,8x4h - PP/INJ
100pcs(1x100pcs)



Area personalizzabile
Customizable area
L4x2h cm



RASCHIETTI
543 ●●●●●
13x8,5h - PP/INJ
20pcs(1x20pcs)



Area personalizzabile
Customizable area
L11x7,2h cm



RASCHIETTI
251 ●●●●●
12,5x8,5h - PP/INJ
20pcs(1x20pcs)



Area personalizzabile
Customizable area
L10,5x7,3h cm



COPERCHIO BOMBATO PER
CONO GELATO
DOME LID FOR ICE CREAM
CONE
090000 ●
Ø6,1 h4,5cm - PET/THF
2400pcs(24x100pcs)



COPERCHIO PIATTO PER CONO
GELATO
FLAT LID FOR ICE CREAM
CONE
090301 ●
Ø6,1 h0,08cm - PET/THF
2400pcs(24x100pcs)



BASTONCINO
366 ●
366-02 ●
L.11 - PS/INJ
4000pcs(5x800)

TARGHETTE PERSONALIZZABILI

Tassello personalizzabile
Customizable plug



Cartellini per torte, segnaposti per il tuo banco gelato: grazie a loro potrai allestire la tua vetrina o il tuo banco frigo in modo semplice e raffinato!
Markers for cakes and ice cream for your counter refrigerator, with them you can decorate your showcase in a refined way!



ROMBO
694-51 ○
9,7x23h - PS/INJ
51pcs



Area personalizzabile
Customizable area
L9,7x8,9h cm

CALICE
693-51 ○
8,8x21,5h - PS/INJ
51pcs

Area personalizzabile
Customizable area
L8,7x7,1h cm

TARGHETTA
692-51 ○
9,6x21,5h - PS/INJ
51pcs

Area personalizzabile
Customizable area
L9,5x7,2h cm

FIORE
697-51 ○
10,2x21,5h - PS/INJ
51pcs

Area personalizzabile
Customizable area
L9,7x7,2h cm



OVALE
696 ○
11,3x6,3x12h - PS/INJ
36pcs



Area personalizzabile
Customizable area
L8,4x5h cm

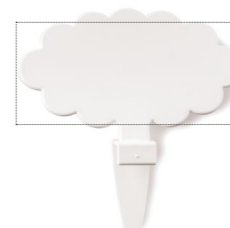

NUVOLETTA
695 ○
11,8x7x12h - PS/INJ
36pcs

Area personalizzabile
Customizable area
L8,4x5h cm

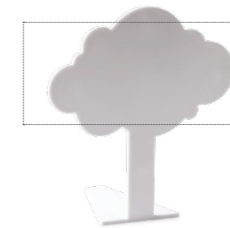

SEGNAPREZZO
679 ○
6,2x10,4xh11,3 - PS/INJ
200pcs(8x25pcs)

Area personalizzabile
Customizable area
L8,4x5h cm



COPPETTE COLORATE MONOPORZIONI



HILLARY 90cc
H90-1 ●
ø7,3x3,7h - PP/INJ
1026pcs(27x38pcs)



HILLARY 120cc
H120-1 ●
ø7,3x4,3h - PP/INJ
1440pcs(40x36pcs)



HILLARY 140cc
H140-1 ●
ø7,8x4,7h - PP/INJ
1260pcs(35x36pcs)



COPERCHIO BOMBATO
DOME LID
H140-BB ●
ø8x3h - PET/THF
1260pcs(35x36pcs)



HILLARY 180cc
H180-1 ●
ø8,1x5h - PP/INJ
1152pcs(32x36pcs)



HILLARY 250cc
H250-1 ●
ø8,4x7,1h - PP/INJ
1088pcs(32x34pcs)



ROTONDA 150cc
252 ●
253 ●●●●●
ø7,5x5,2h - PS/INJ
1000pcs(25x40pcs)



COPERCHIO PIATTO
FLAT LID
252-CB ●
ø7,5x0,8h - PET/THF
1000pcs(10x100pcs)



ROTONDA 200cc
254 ●
255 ●●●●●
ø9,5x4,5h - PS/INJ
900pcs(18x50pcs)



COPERCHIO PIATTO
FLAT LID x200/250cc
255-C ●
ø9,5 - PS/INJ
900pcs(9x100pcs)

BICCHIERI PER DESSERT E FRUTTA DA BANCO FRIGO



BASE
064112 ●
ø6x7,8h - PS/INJ
400pcs(20x20pcs)



FLUTE 100cc
064001 ●
ø5,2x10,8h - PS/INJ
400pcs(20x20pcs)



COPERCHIO/LID
064202 ●
ø5,5x1h - PET/THF
400pcs(4x100pcs)



Art. 064114 ○



Art. 064104 ●



Art. 064102 ●



Art. 064113 ●



Art. 064120 ●



Art. 064107 ●



Art. 064109 ●



Art. 064103 ●



Art. 064111 ●



Art. 064110 ●



Art. 064116 ●



Art. 064122 ●



Art. 064108 ●



Art. 064105 ●



Art. 064118 ●



Art. 064117 ●



Art. 064106 ●



Art. 064119 ●



FREEZE 300cc
100900 ●
ø8,4x11,6h - PP/INJ
420pcs(21x20pcs)



COPERCHIO/LID x300cc
469-CB ●
ø8,7x2,1h - PET/THF
600pcs(12x50pcs)

CUCCHIAIO PERSONALIZZABILE CON ETICHETTA

Etichetta personalizzabile
Customizable label

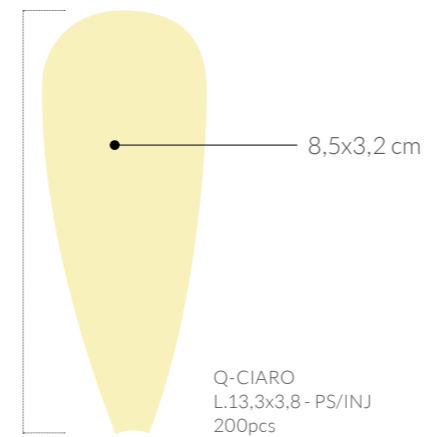

Cucchiaino dotato di etichetta IML da poter personalizzare con la propria grafica! Un'ottima idea per un kit perfetto o per un gadget promozionale!
Spoon with IML label to be customized with your graphic. A good idea for a kit or as a promotional gadget.



7,5
0,9
CUCCHIAINI

PALETTE



CIRO IMBUSTATO
123000-IT ○
L.5,8 - PS/INJ
5000pcs



CIRO
123000 ○
L.5,8 - PS/INJ
3000pcs(10x300pcs)



PAPY
124100 ○
L.6,28 - PS/INJ
3000pcs(10x300pcs)



REMO
123100 ○
L.8 - PS/INJ
1800pcs(6x300pcs)



SARDINA
123201 ○
123200 ●
L.9,7 - PS/INJ
1500pcs(5x300pcs)



STRONG

Cucchiaini ideali per gelati industriali confezionati dalla solida consistenza. Disponibili in diverse forme, misure e colori, sono perfetti anche da assemblare al tuo packaging.
Ideal spoons for packed industrial ice cream. Available in different shapes, sizes and colors, perfect for your packaging.



PINCO
123700 ●●●●
L.11,5 - PS/INJ
400pcs(4x100pcs)

PINCO
Art. 123703 ●●●●
L.11,5 - PS/INJ
1000pcs(4x250pcs)



PANCO
Art. 123600 ●●●●
L.15 - PS/INJ
400pcs(4x100pcs)

SPOON'S BOX

Pratico box salvaspazio per la distribuzione dei cucchiaini. Il nostro team creativo è a disposizione per creare la tua soluzione di packaging perfetta.
Practical and save space box for spoons. Our creative team will be at your disposal to create the perfect packaging solution.

Box personalizzabile
Customizable box



SINGLE WRAPPED
232-00-IT ●
L.9,5 - PS/INJ
5000pcs(10x100pcs)



SINGLE WRAPPED
232-IT ●●●●●
L.9,5 - PS/INJ
5000pcs(10x100pcs)



BOX PALETTINE
232BOX2
L.18x16x27h - PAPER
6000pcs(12x500pcs)



TRANSPARENT
232-00 ●
L.9,5 - PS/INJ
10Kg(10x1Kg)



TRANSPARENT COLORS
232 ●●●●●
L.9,5 - PS/INJ
10Kg(10x1Kg)



FULL COLORS
231 ●●●●●
L.9,5 - PS/INJ
10Kg(10x1Kg)



FULL COLORS
231-11 ● / **231-10** ○
L.9,5 - PS/INJ
10Kg(10x1Kg)



TEXAS
122702 ●●●●●
L.7,5 - PS/INJ
10Kg(10x1Kg)



TEXAS IMBUSTATO
1227-IT ●●●●●
L.7,5 - PS/INJ
6000pcs(6x1000pcs)

Small changes can make a big Difference



COMPOSTABLE

Negli ultimi anni lo sviluppo della chimica verde ha portato sul mercato polimeri biobased, contenenti fonti vegetali rinnovabili, con performance e costi competitivi rispetto ai polimeri tradizionali.

Questi biopolimeri sono formulati in maniera da risultare compostabili, ovvero smaltibili in impianti di compostaggio industriale insieme ai rifiuti organici. È il caso di due materiali che utilizziamo per produrre i nostri articoli compostabili.

Tutta la gamma di prodotti compostabili Poloplast mantiene intatte le caratteristiche di rigidità, è idonea al contatto alimentare ai sensi del Regolamento UE n. 10/2011 (e successive modifiche) e rispetta le direttive della norma UNI EN13432 in materia di compostabilità.

Il compost ottenuto dallo smaltimento di questi articoli fertilizzerà il terreno su cui poi nasceranno altre piante dalle quali si otterranno nuovamente materie prime. Un circolo virtuoso che comporta meno impiego di risorse non rinnovabili, meno energia e meno CO₂.

Al fine di mantenerne intatte le caratteristiche, gli articoli compostabili devono essere stoccati in ambiente fresco e asciutto, lontano da fonti di luce e di calore.

In recent years the development of green chemistry has brought to the market bio-based polymers, containing renewable plant sources, with competitive performance and costs compared to traditional polymers.

These biopolymers are compostable, and should be disposed in industrial composting plants together with organic waste. This is the case of two materials we use to produce our compostable articles.

The whole range of Poloplast compostable products keeps intact the characteristics of rigidity, it is suitable for food contact according to EU Regulation n. 10/2011 (and subsequent amendments) and complies with the directives of the UNI EN13432 standard on compostability.

The compost obtained from the disposal of these articles will fertilize the soil on which regrow other plants, used to create again raw materials. A virtuous circle that involves less use of non-renewable resources, less energy and less CO₂.

The compostable materials must be stored in a cool and dry environment, away from sources of light and heat.



COPPETTE CON COPERCHIO



COPERCHIO BOMBATO
DOME LID x80cc
Compostable
700-BB-PLA ●●
ø8,5x4h - PLA/THF
1200pcs(24x50pcs)



COPERCHIO BOMBATO
DOME LID x100cc
Compostable
701-BB-PLA ●●
ø9x4h - PLA/THF
1200pcs(24x50pcs)



COPERCHIO BOMBATO
DOME LID x150cc
Compostable
703-BB-PLA ●●
ø10,2x3,4h - PLA/THF
1000pcs(20x50pcs)



COPERCHIO BOMBATO
DOME LID x200cc
Compostable
703-BB-PLA ●●
ø10,2x3,4h - PLA/THF
1000pcs(20x50pcs)



FOGLIA 80cc
Compostable
073000 ●●
ø7,5x3,4h - PLA/THF
200pcs(12x100pcs)



FOGLIA 100cc
Compostable
073100 ●●
ø8x3,8h - PLA/THF
1200pcs(12x100pcs)



FOGLIA 150cc
Compostable
073200 ●●
ø9,3x3,9h - PLA/THF
1000pcs(10x100pcs)



FOGLIA 200cc
Compostable
073300 ●●
ø9,3x5,3 - PLA/THF
1000pcs(10x100pcs)



COPERCHIO BOMBATO
DOME LID x250cc
Compostable
031193 ●
ø11,2x5,1h - PLA/THF
600pcs(12x50pcs)



COPERCHIO BOMBATO
DOME LID x350cc
Compostable
705-BB-PLA ●●
ø11,2x4h - PLA/THF
800pcs(8x100pcs)



COPERCHIO BOMBATO
DOME LID x450cc
Compostable
706-BB-PLA ●
ø13,1x5,7h - PLA/THF
800pcs(8x100pcs)



FOGLIA 250cc
Compostable
073400 ●●
ø10,2x5,3h - PLA/THF
800pcs(8x100pcs)



FOGLIA 350cc
Compostable
073500 ●●
ø10,9x6,6h - PLA/THF
800pcs(8x100pcs)



FOGLIA 450cc
Compostable
073600 ●●
ø12x7h - PLA/THF
800pcs(8x100pcs)



FOGLIA 550cc
Compostable
073700 ●●
ø12,8x7,5h - PLA/THF
900pcs(9x100pcs)

PALETTINE



CIRO
Compostable
123003
L.5,8 - PLA/INJ
3000pcs(10x300pcs)



PAPY
Compostable
124104
L.6,28 - PLA/INJ
3000pcs(10x300pcs)



TEXAS
Compostable
122703
L.7,5 - PLA/INJ
10Kg (10 cf x 1 Kg)

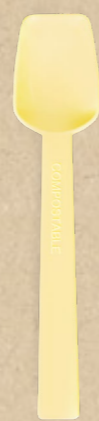

DUE3DUE
Compostable
232-21PLA
232-00PLA
L.9,5 - PLA/INJ
10Kg (10 cf x 1 Kg)

HAWAII
Compostable
124800
124801
124802
124803
L.9,5 - PLA/INJ
10Kg (10 cf x 1 Kg)



ICE CURVY S
Compostable
124400
124401
124402
124403
124404
L.12 - PLA/INJ
5Kg(5 cf x 1 kg)

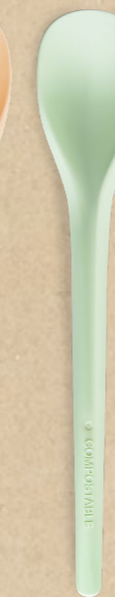

ICE CURVY M
Compostable
124600
124601
124602
124603
124604
L.15 - PLA/INJ
5Kg(5 cf x 1 kg)

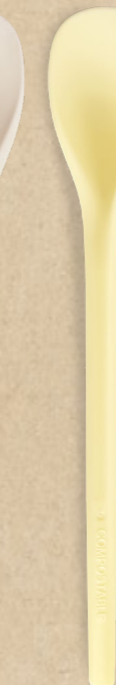
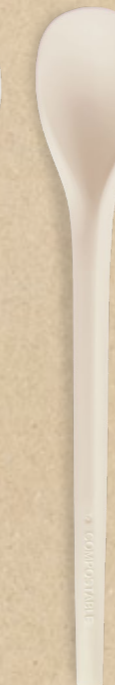

ICE CURVY L
Compostable
124700
124701
124702
124703
124704
L.17,5 - PLA/INJ
5Kg(10 cf x 500 gr)



Ri-
spetta
l'ambiente
con i nostri cuc-
chiaini compostabili!
Disponibili in varie mi-
sure e nelle nuove nuance
pastello, daranno il giusto
tocco di originalità ai tuoi pro-
dotti.
Respect the environment with
our compostable spoons! Avail-
able in different sizes and in
new pastel colors, they will
give a touch of originality
to your products.



DESSERT AL BICCHIERE & CO.

Tutto il gusto delle tue specialità... rispettando l'ambiente. Dopo il loro utilizzo, grazie alla raccolta differenziata, gli articoli compostabili presenti in questo catalogo verranno portati in siti di compostaggio industriale e dopo un processo di degradazione torneranno ad essere Humus che migliorerà la struttura del suolo.

All the taste of your specialties ... respecting the environment. After their use, thanks to the differentiated collection, the compostable articles present in this catalogue will be brought to industrial composting sites and after a degradation process, they will return to being Humus which will improve the soil structure.



YUMMY 500cc
Compostable
040400 ●●
Ø10,5x10h - PLA/THF
500pcs(10x50pcs)

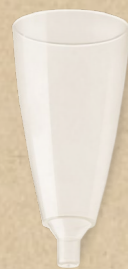

CHAMPAGNE 100cc
Compostable
064005 ●●
ø5,2x10,8h - PLA/INJ
400pcs(20x20pcs)



BASE IMPILA
Compostable
064303 ●●
ø6x6,2h - PLA/INJ
400pcs(20x20pcs)



COMPOSTABLE

PORTA DESSERT

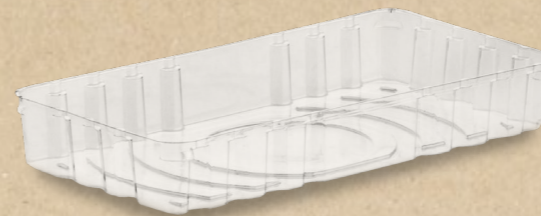

CAKE AWAY RETTANGOLARE
Compostable
063401 ●●
21x11x3h - PLA/THF
300pcs



CAKE AWAY QUADRATO
Compostable
063501 ●●
21x21x3h - PLA/THF
200pcs



Polo Plast Srl

HEADQUARTER & SHOP

Via Sandro Pertini 1, 30029 San Stino di Livenza (VE) Italia

Tel. +39 0421 16703 **Fax** +39 0421 461761 **P.iva** 03047060268

info@poloplast.it

poloplast@legalmail.it

www.poloplast.it

POLO *shop*

Shop

Via Sandro Pertini 1, 30029 San Stino di Livenza (VE) Italia

dal Lunedì al Venerdì dalle 8.30 alle 18.30

Shop online

www.poloplastshop.it

Follow

